

MARCY[®]

ELITE LEG TRAINER MWM-0418

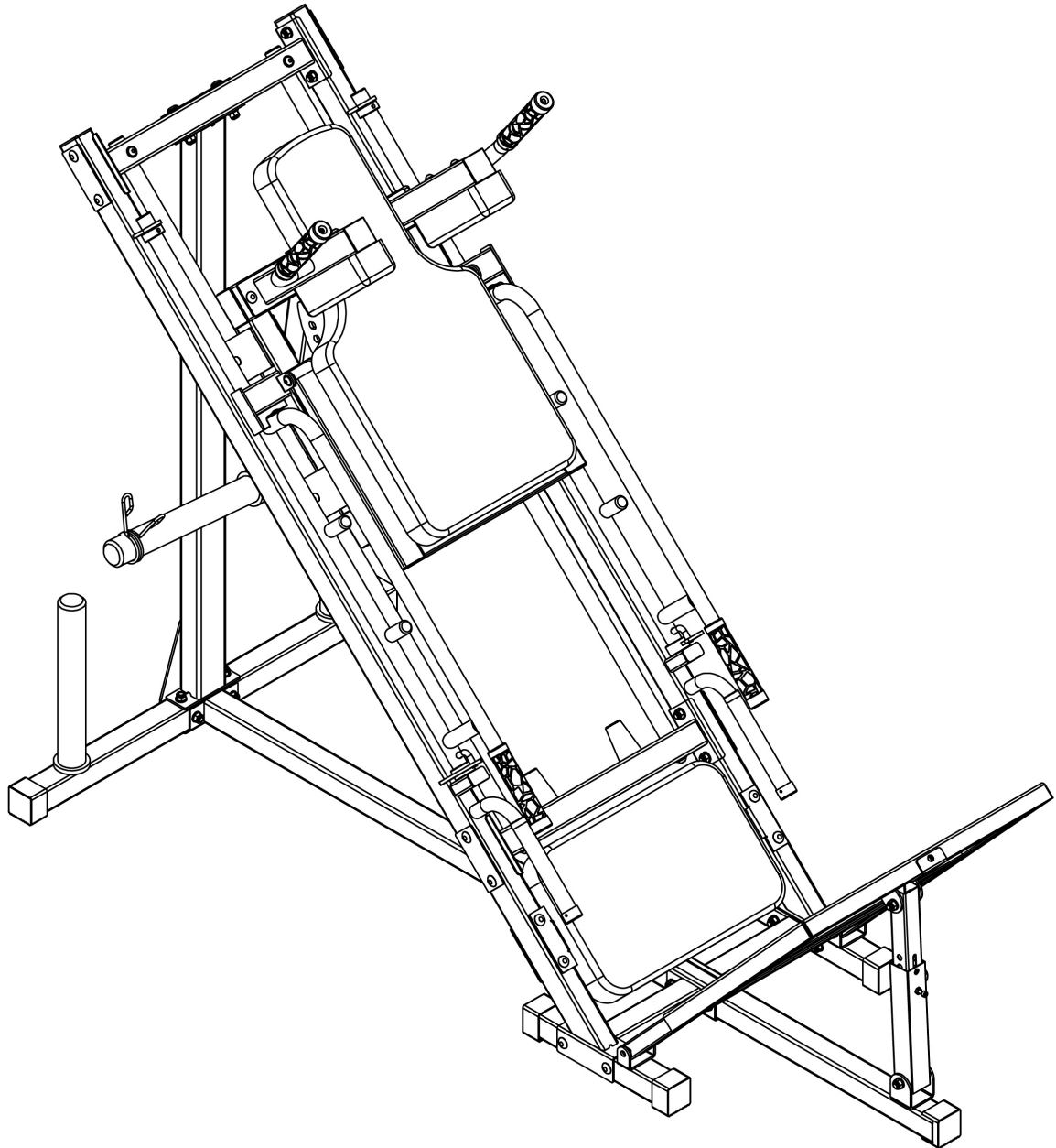

IMPORTANT: Please read the Important Safety Notice and Assembly Information in the Owner's manual before assembling this product.

Assembly Manual

241023

HARDWARE PACK

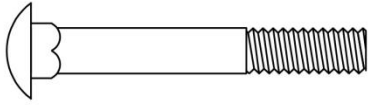

#42 M10X2 3/8" MM Carriage Bolt (Qty8)

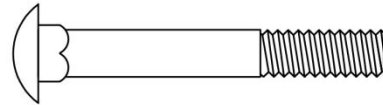

#43 M10X2 3/4" MM Carriage Bolt (Qty22)

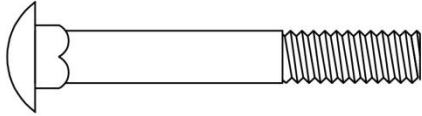

#44 M10X3 1/8" MM Carriage Bolt (Qty4)

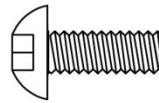

#45 M10X 3/4" MM Allen Bolt (Qty6)

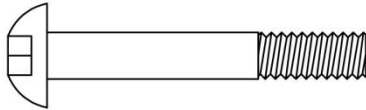

#46 M10X2 3/4" MM Allen Bolt (Qty1)

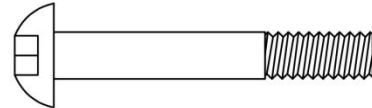

#47 M10X3" MM Allen Bolt (Qty1)

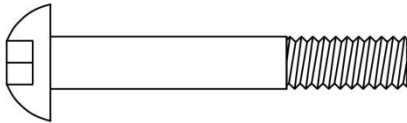

#48 M10X3 1/8" MM Allen Bolt (Qty2)

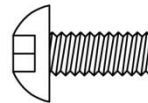

#49 M8X 5/8" MM Allen Bolt (Qty4)

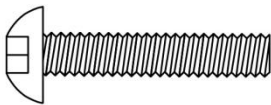

#50 M8X2 1/2" MM Allen Bolt (Qty4)



#51 M10 MM Aircraft Nut (Qty38)

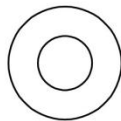

#52 ϕ 3/4" MM Washer (Qty44)

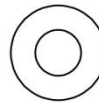

#53 ϕ 5/8" MM Washer (Qty10)

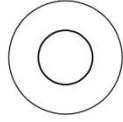

#54 ϕ 1" \times ϕ 3/4" MM Washer (Qty4)

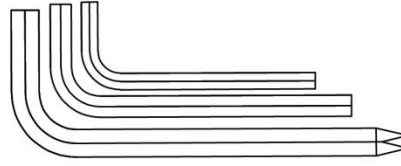

Allen keys 4# ,5#,6#,each one

COMPONENTS FOR ASSEMBLY

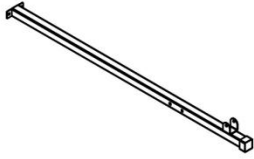

① × 1

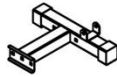

② × 1

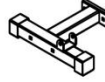

③ × 1

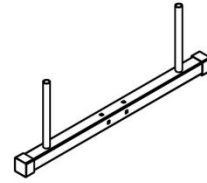

④ × 1



⑤ × 1

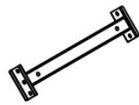

⑥ × 1

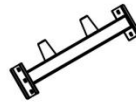

⑦ × 1

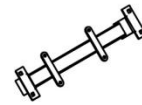

⑧ × 1

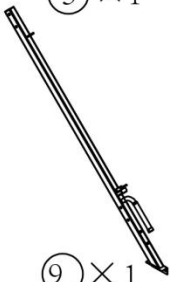

⑨ × 1

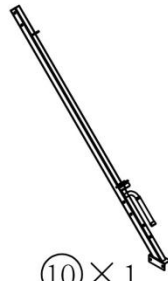

⑩ × 1

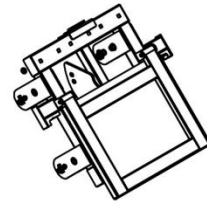

⑪ × 1

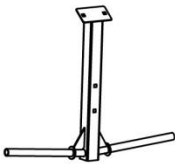

⑫ × 1



⑬ × 1



⑭ × 1



⑮ × 1

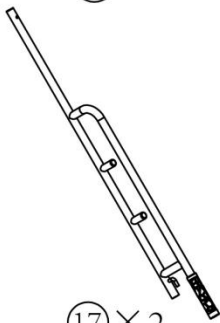

⑰ × 2



⑱ × 1



⑳ × 1

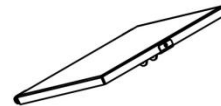

㉑ × 1

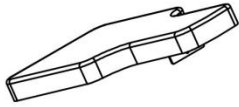

②⑦ × 1

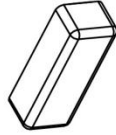

②⑧ × 2



②⑨ × 1

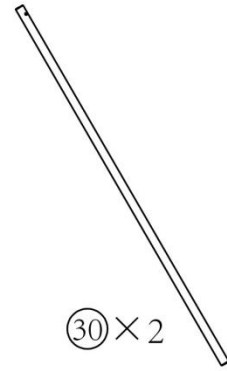

③⑦ × 2

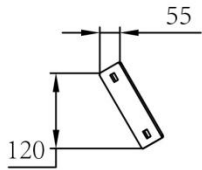

③③ × 4

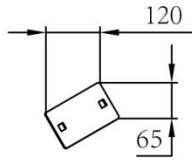

③④ × 4

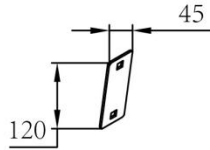

③⑤ × 1

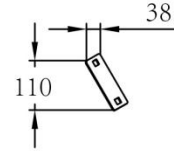

③⑥ × 2

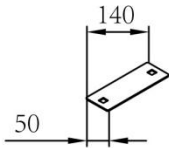

③⑦ × 2



③⑧ × 1



③⑨ × 1



④① × 2

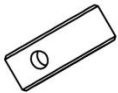

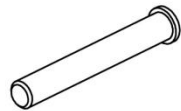

⑥⑦ × 2



⑧② × 4

ASSEMBLY STEP 1

④3		2	M10 × 2 3/4"
⑤2		2	φ3/4"
⑤1		2	M10

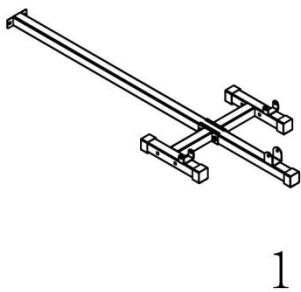
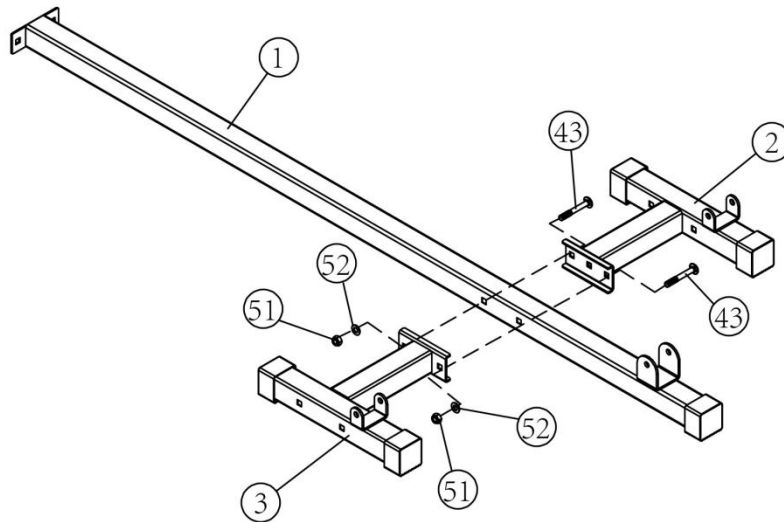
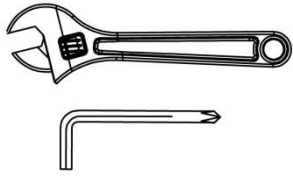

ASSEMBLY STEP 2

④③  4 M10 × 2 3/4"

⑤②  4 ϕ 3/4"

⑤①  4 M10

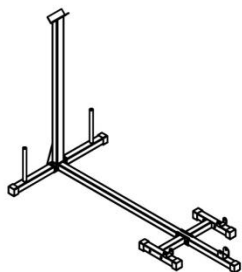
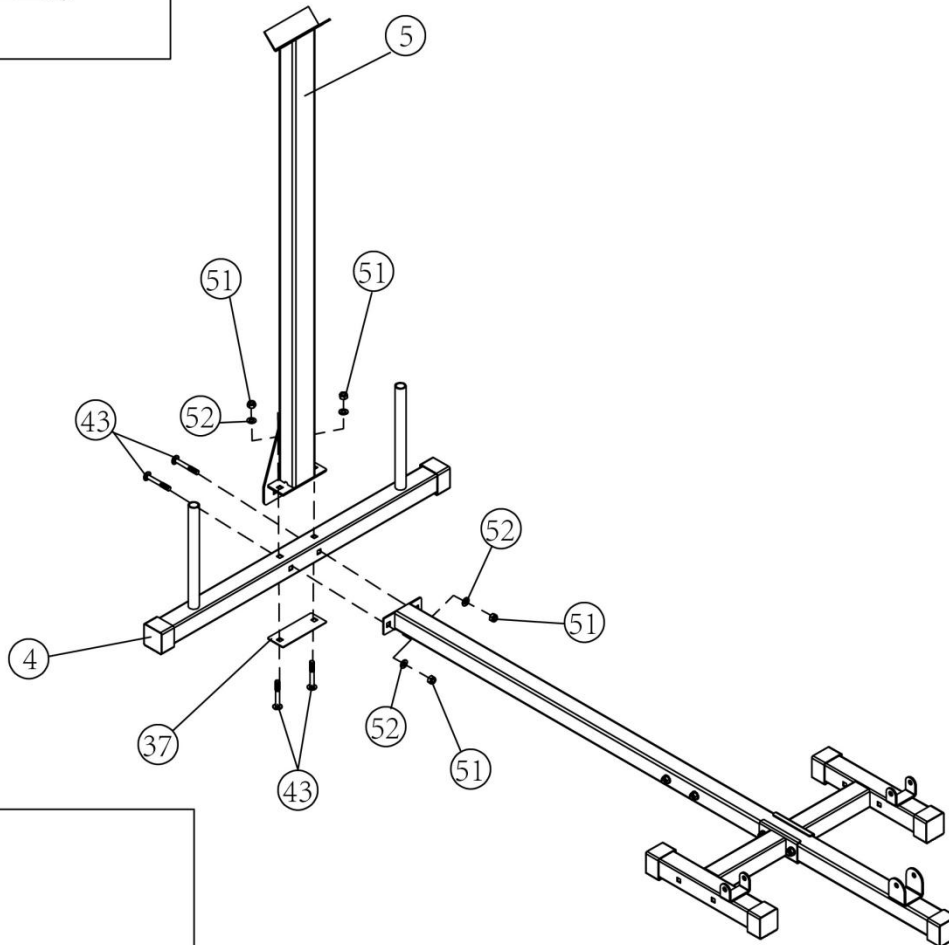

2

ASSEMBLY STEP 3



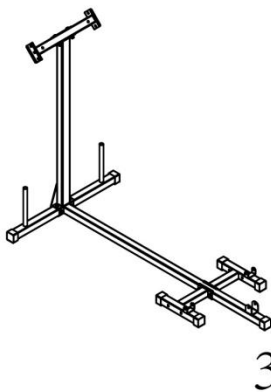
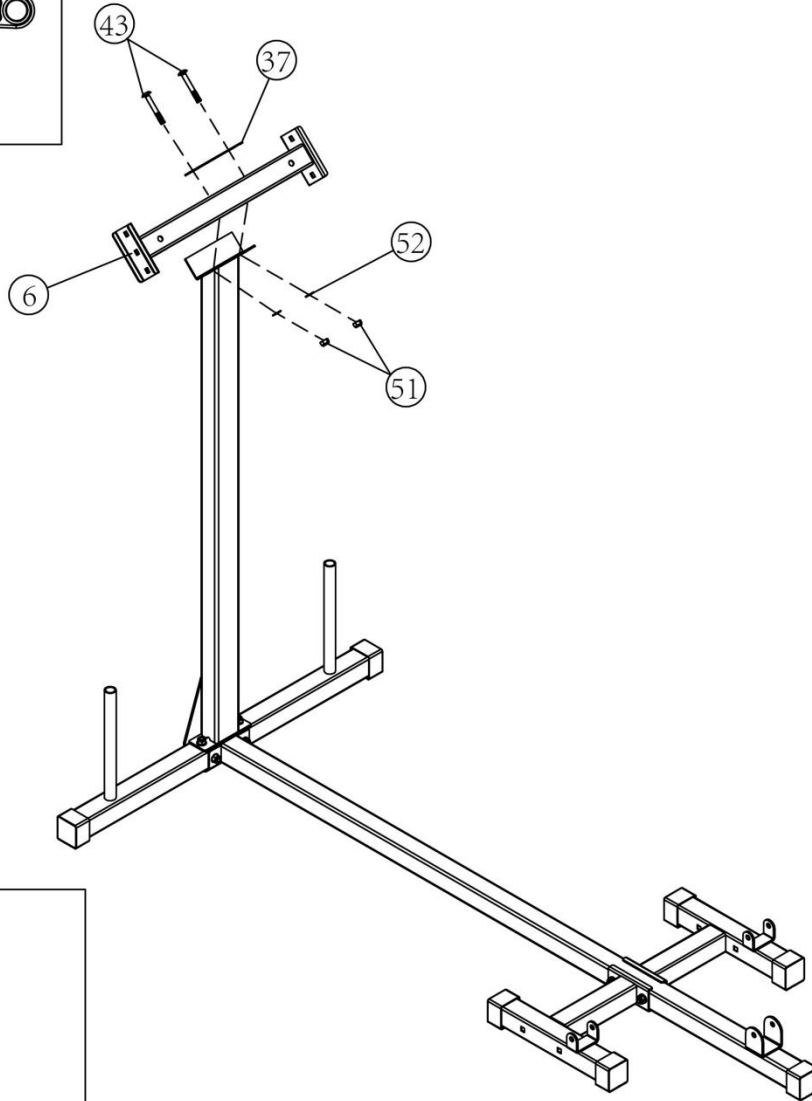
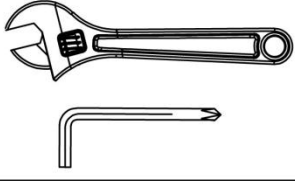

④③  2 M10 × 2 3/4"

⑤②  2 ϕ 3/4"

⑤①  2 M10

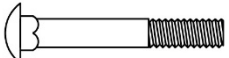
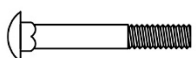

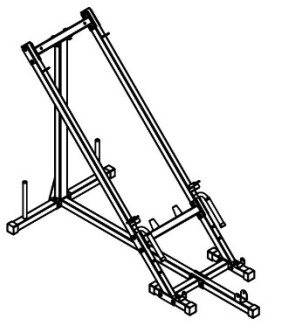
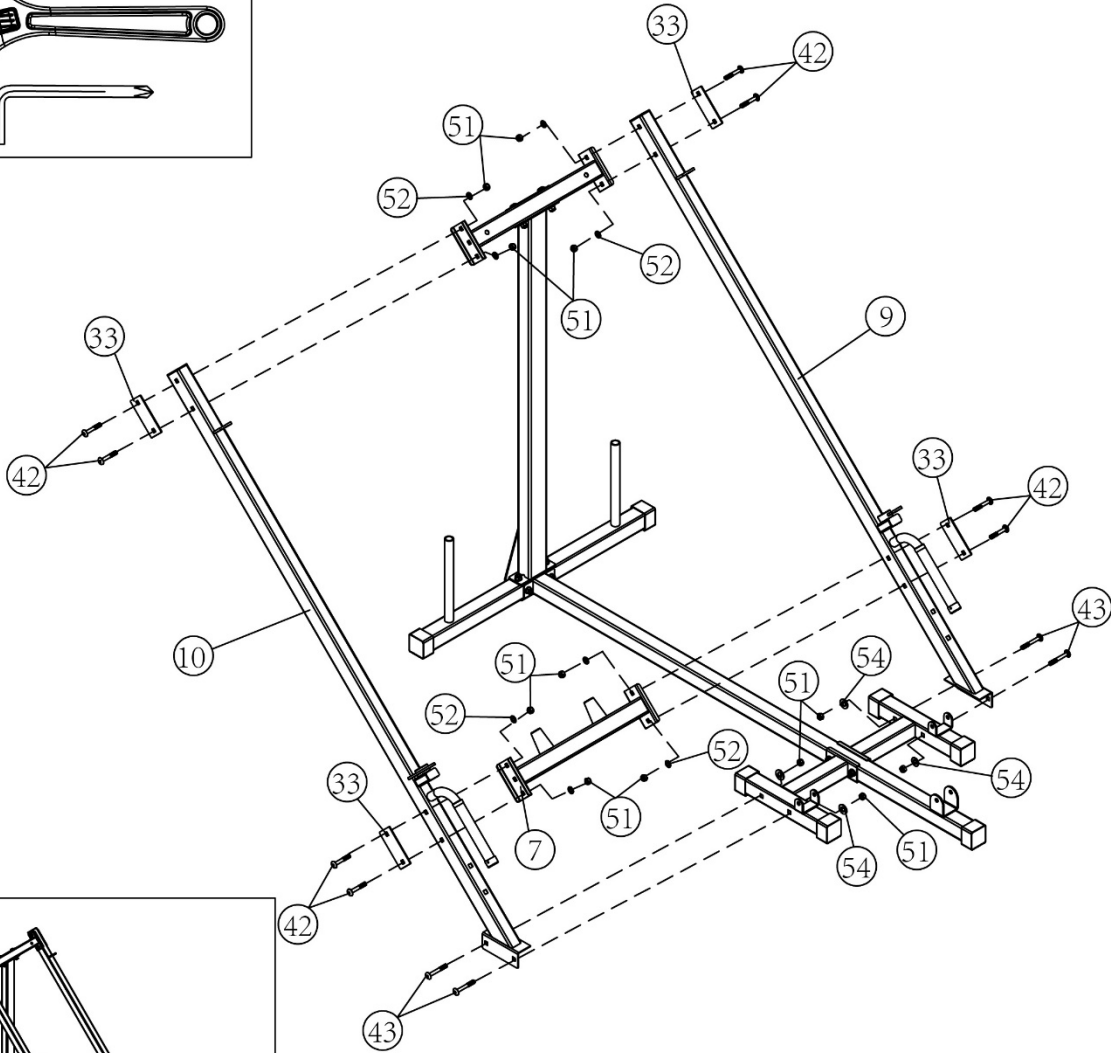
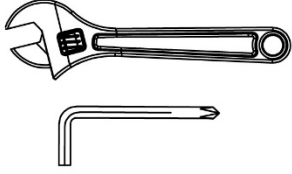

ASSEMBLY STEP 4

- | | | | | | | | |
|----|---|----|------------|----|--|---|-------------|
| ④② |  | 8 | M10×2 3/8" | ④③ |  | 4 | M10×2 3/4" |
| ⑤② |  | 8 | φ 3/4" | ⑤④ |  | 4 | φ 1"×φ 3/4" |
| ⑤① |  | 12 | M10 | | | | |



4

ASSEMBLY STEP 5

- | | | | |
|----|---|---|--------------|
| ④④ |  | 4 | M10 × 3 1/8" |
| ⑤② |  | 4 | φ 3/4" |
| ⑤① |  | 4 | M10 |

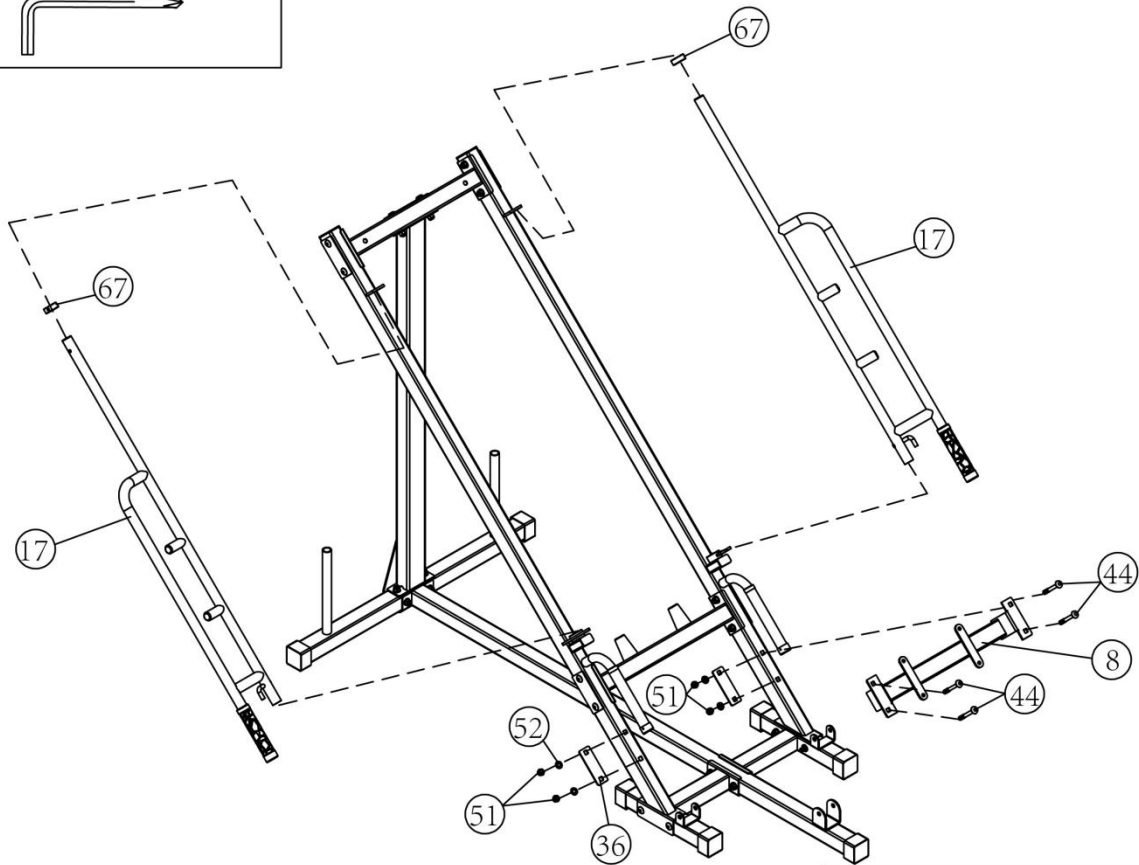
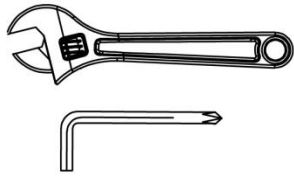

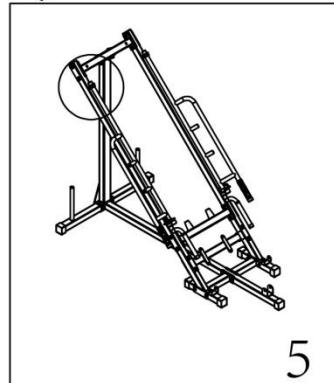
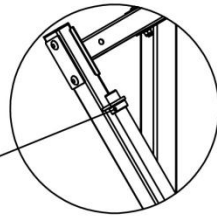

tighten it with
an allen wrench



5

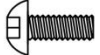

ASSEMBLY STEP 6

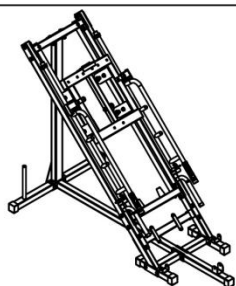
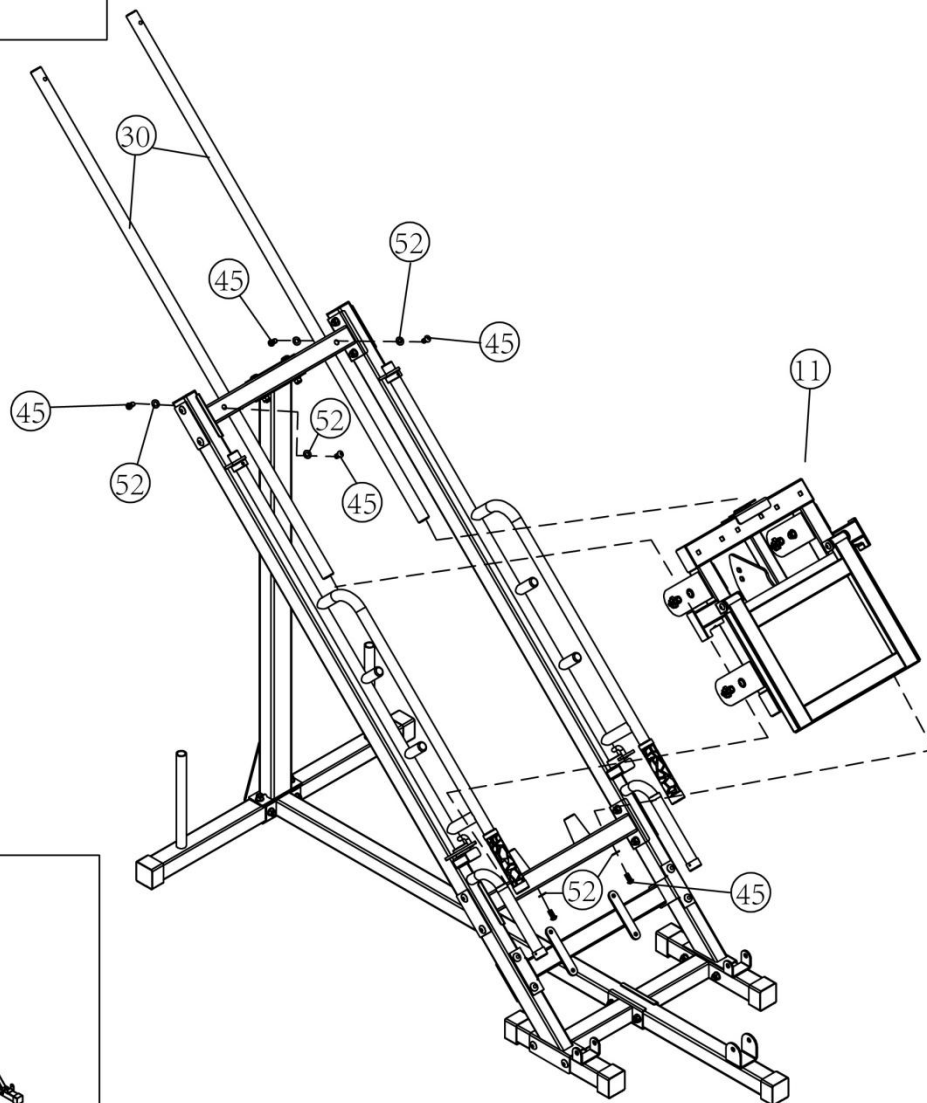
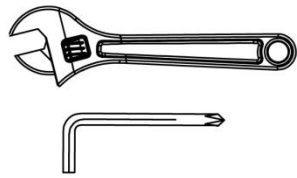
- | | | | |
|----|---|---|------------|
| ④5 |  | 6 | M10 × 3/4" |
| ⑤2 |  | 6 | φ 3/4" |

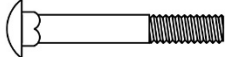

6

ASSEMBLY STEP 7

④3		6	M10×2 3/4"
⑤2		6	φ 3/4"
⑤1		6	M10

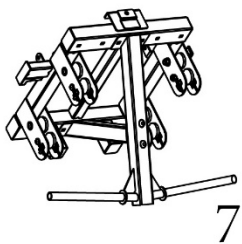
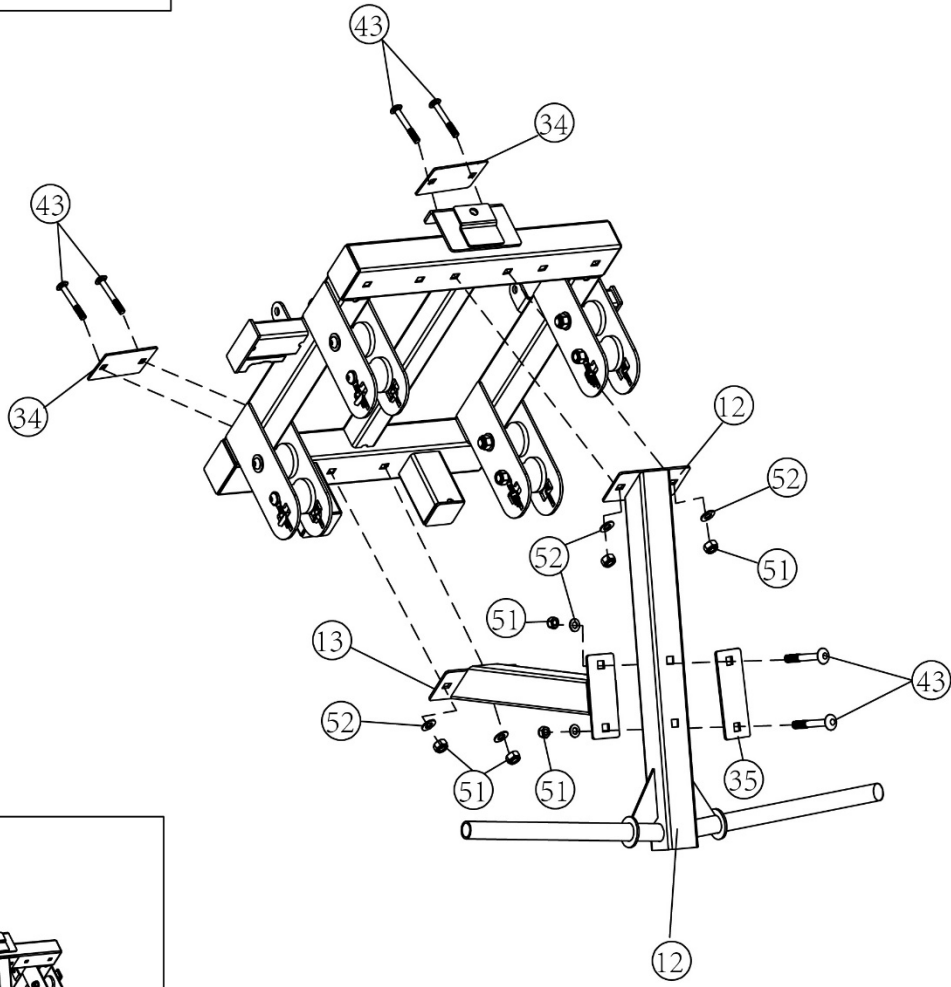
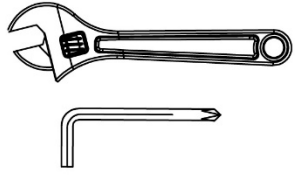

ASSEMBLY STEP 8

④③  4 M10 × 2 3/4"

⑤②  4 ϕ 3/4"

⑤①  4 M10

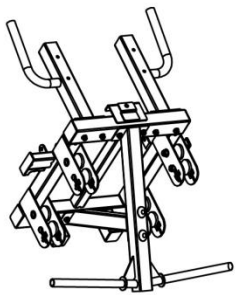
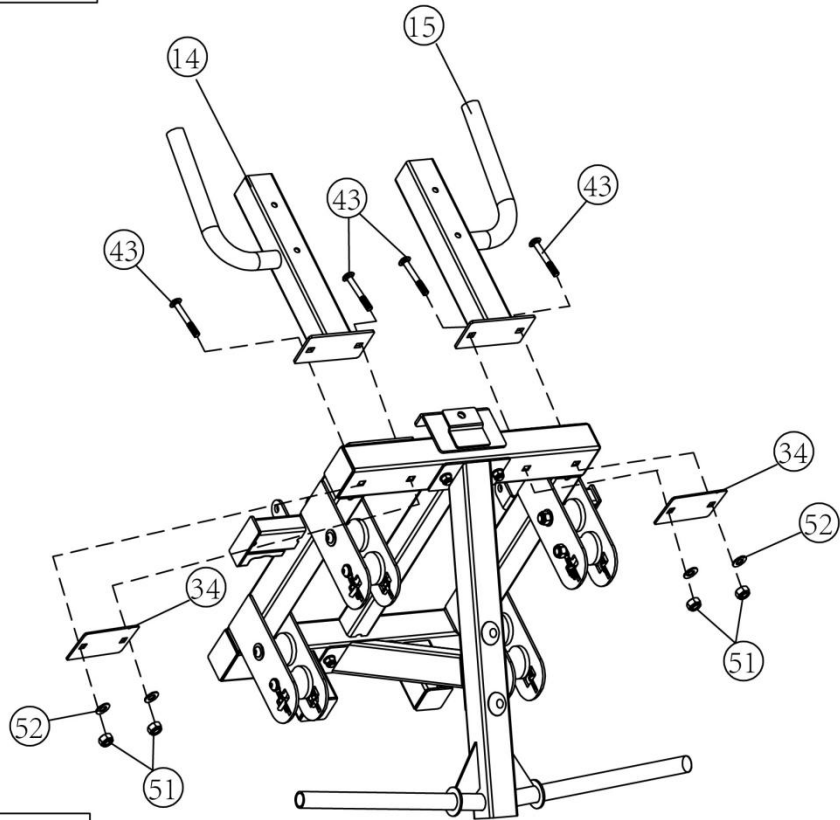
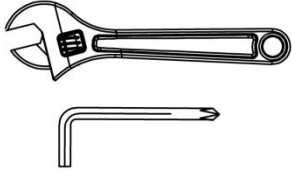

8

ASSEMBLY STEP 9

④⑥  1 M10 × 2 3/4"

④⑦  1 M10 × 3"

⑤②  8 ϕ 3/4"

④⑧  2 M10 × 3 1/8"

⑤①  4 M10

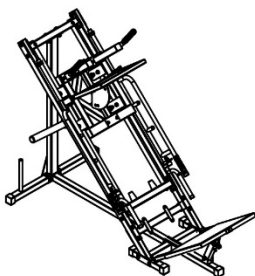
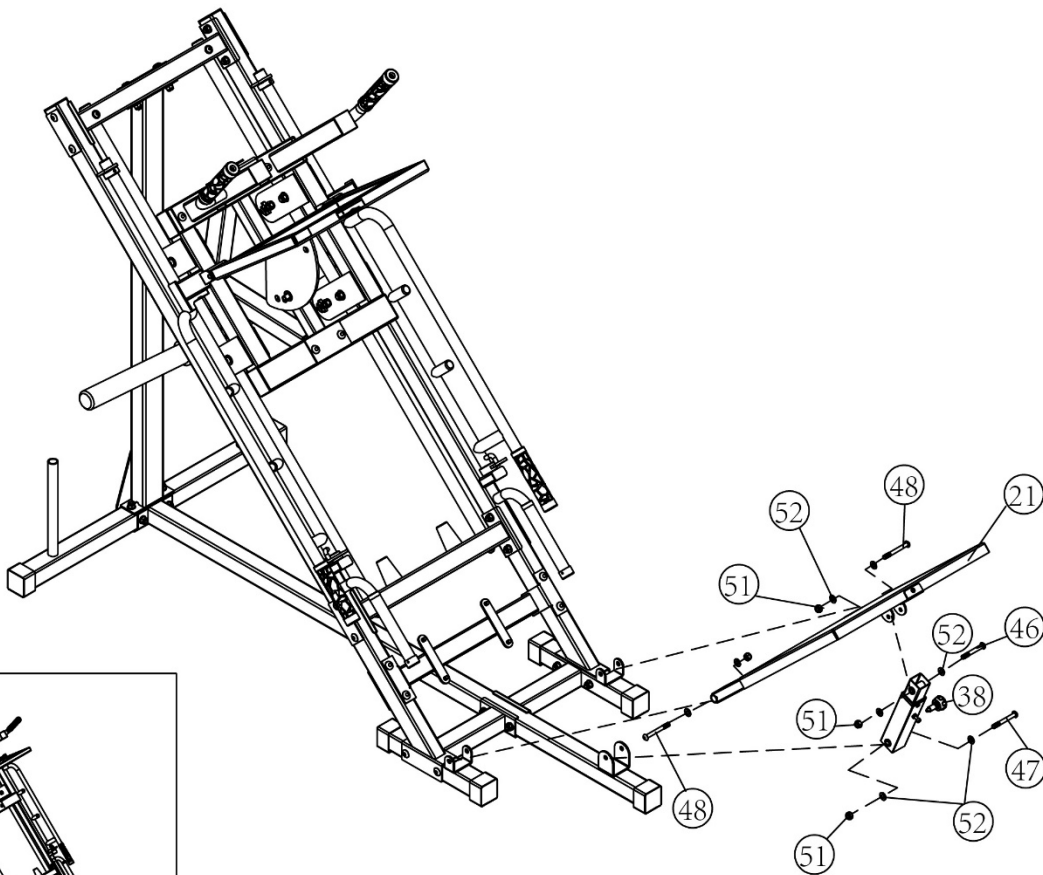
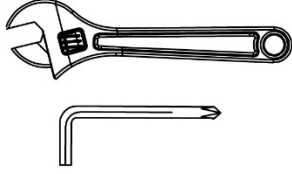

9

ASSEMBLY STEP 10

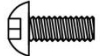
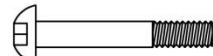
- | | | | | | | | |
|----|---|---|-----------|----|--|---|-------------|
| ④9 |  | 4 | M8 × 5/8" | ⑤0 |  | 4 | M8 × 2 1/2" |
| ⑤3 |  | 8 | φ 8 | | | | |

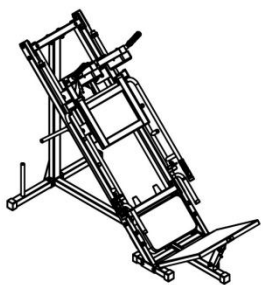
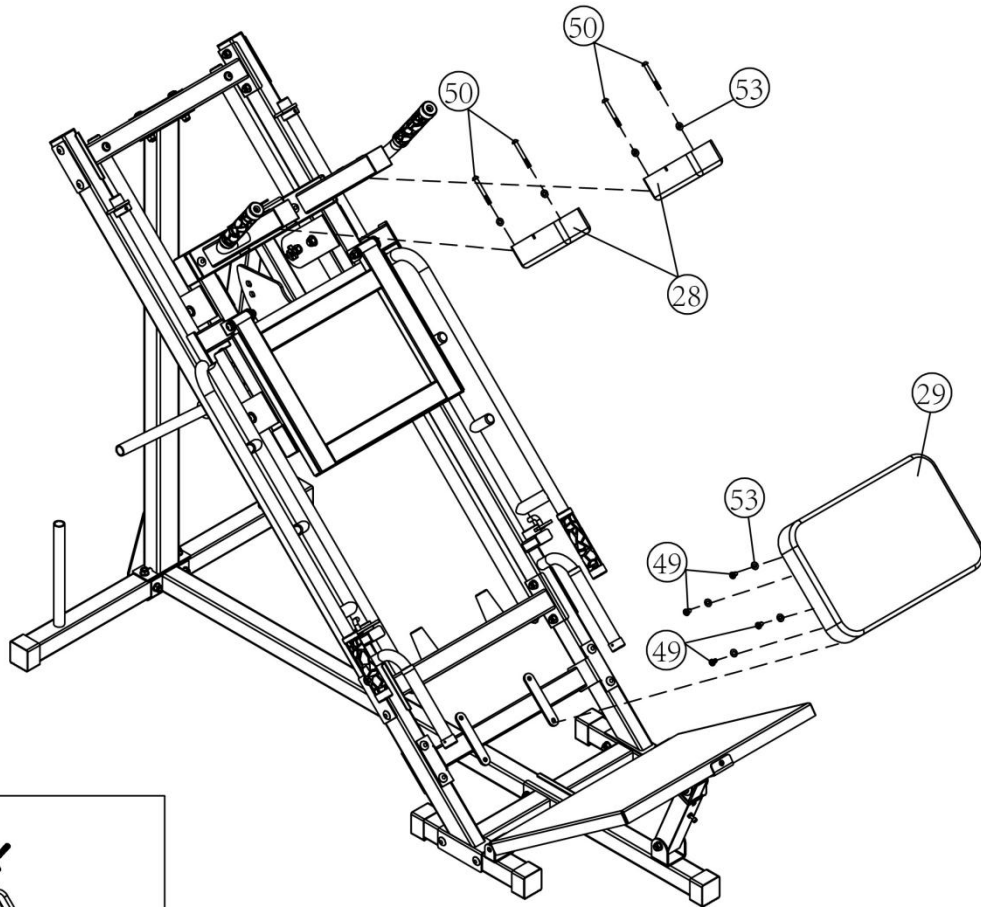
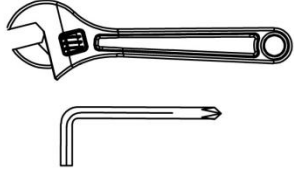

10

ASSEMBLY STEP 11

39



41

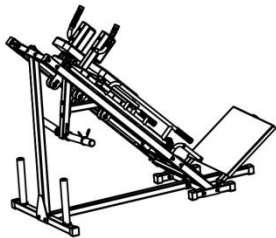
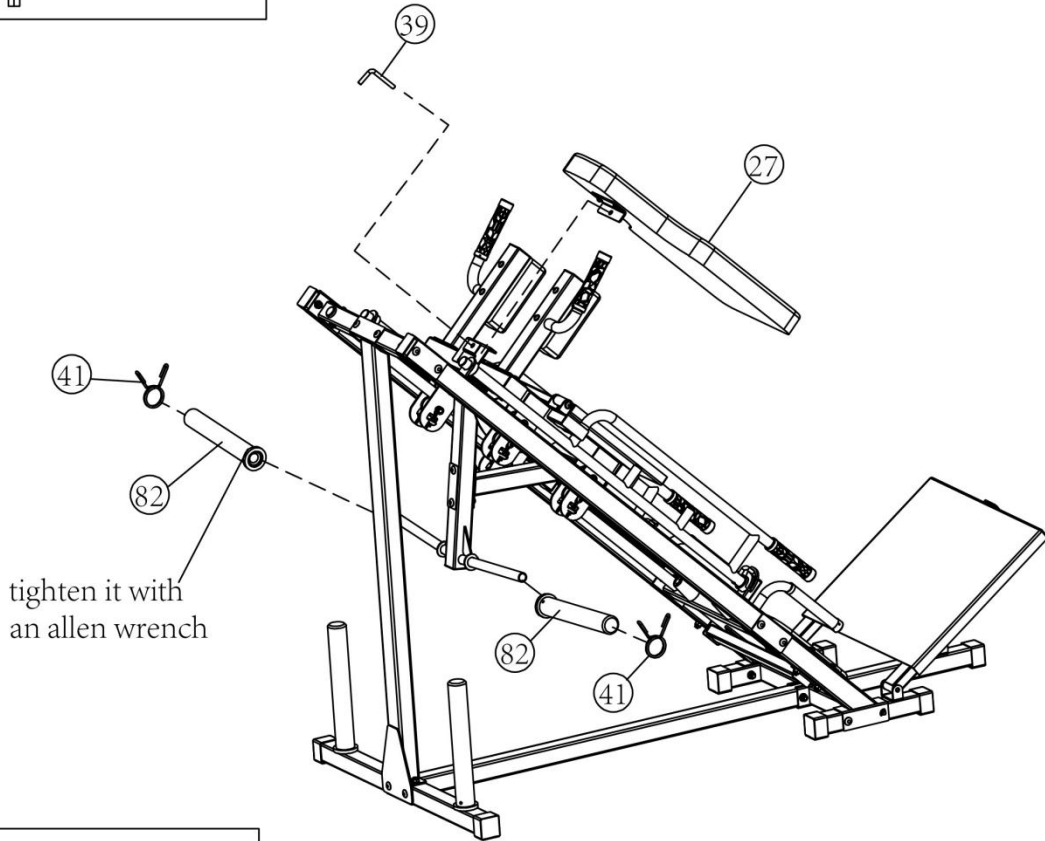
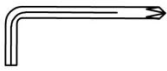

11

IMPEX® INC.

2801 S. Towne Ave. Pomona, CA 91766

Tel: (800) 999-8899

www.marcypro.com

support@impex-fitness.com